

VALVE REPAIR AND TESTING EQUIPMENT AND MORE



Serving the World

Since EFCO was established in 1978, we have been a world leading manufacturer of portable and stationary valve repair and testing equipment. The company has been a family-run business with the philosophy of making our customers our partners. We can jointly solve problems concerning machining and testing of sealing surfaces in valves and flanges of all types.

Experience has shown that preventative maintenance is the cheapest way of increasing the safety of your installations. Once the first faults occur, costs frequently balloon, because actions have to be taken under enormous time pressure in such cases. In addition to environmental damages and high clean-up costs, unquantifiable damage to your image may arise.

With targeted use of EFCO technology, you achieve not just a high level of safety, but also save significant amounts of time and money in the long term and make an additional contribution to environmental protection – without additional costs.

EFCO machines are used worldwide and are characterised by:

- Excellent quality
- Durability
- Operator-friendly handling
- First-class repair results

As a world-leading manufacturer of portable and stationary valve repair and testing technology, we are certified to DIN EN ISO 9001.

We are able to maintain our market leadership due to flexibility, continuous process improvements, short information paths as well as dealing actively and positively with problems.

Our product range includes:

- Portable and stationary machining and repair machinery for valves, flanges and pipelines
- Surface grinding and lapping machines
- Valve test benches
- Workshops, mobile and stationary
- Planning of workshops
- Consumables
- And much more

Please contact our team in Düren, our sales offices or our sales partners for further information or if you have any questions. You can also visit us on the internet at www.efco-dueren.com

We will gladly demonstrate our machines, also at your facility.





- Apparatus construction
- Boiler manufacturers
- Chemical industry
- Combined heat and power stations
- District heating suppliers
- Fertilizer plants
- Food industry
- Fossil power plants
- Gas manufacturers
- Hydroelectric power plants
- Manufacturers of valves
- Mining
- Nuclear power stations
- Paper industry / cellulose
- Petrochemical plants / refineries
- Pharmaceutical industry
- Pipelines
- Plant construction
- Refuse incinerators
- Rubber manufacturers
- Shipping companies
- Shipyards
- Steel industry
- Steel works
- Sugar refineries
- Valves service companies
- Valves trade
- Water treatment plants





GRINDING AND LAPPING EQUIPMENT



TURNING EQUIPMENT



TESTING EQUIPMENT



OTHER PRODUCTS



Flat Seats / Safety Valves:

| Mobile Machining | | Stationary Machining | |
|------------------|--------------------------------|----------------------|--------------------------------|
| VALVA | Grinding and lapping equipment | SM-D | Grinding and lapping equipment |
| VSA | Grinding equipment | TSV | Grinding and lapping equipment |
| TSV | Grinding and lapping equipment | MK/ENT | Grinding equipment |
| TD | Turning equipment | KS-6 | Grinding equipment* |
| TDF | Turning equipment | SPM | Turning equipment |
| CW-1000 | Welding equipment | PDM | Turning equipment |
| | | FLM | Lapping equipment* |
| | | CW-1000 | Welding equipment |

* not for safety valve

Conical Seats:

| Mobile Machining | | Stationary Machining | |
|------------------|-------------------------------|----------------------|-------------------|
| VSK | Grinding equipment | SPM | Turning equipment |
| LS | Grinding equipment | PDM | Turning equipment |
| VSA | High-speed grinding equipment | CW-1000 | Welding equipment |
| TD | Turning equipment | | |
| TD-2NC | Turning equipment | | |
| CW-1000 | Welding equipment | | |

Flanges / Bores / Pressure Seals:

| Mobile Machining | | Stationary Machining | |
|------------------|--------------------------------|----------------------|-------------------|
| TDF | Turning equipment | SPM | Turning equipment |
| TDFI-2 | Turning equipment | PDM | Turning equipment |
| TDF-2NC | Turning equipment | | |
| SL | Grinding and lapping equipment | | |
| TD | Turning equipment | | |
| TD-2NC | Turning equipment | | |

Gate Valves And Check Valves:

| Mobile Machining | | Stationary Machining | |
|------------------|--------------------------------|----------------------|--------------------|
| SL | Grinding and lapping equipment | SM-N | Grinding equipment |
| HSL | High-speed grinding equipment | KS | Grinding equipment |
| | | FLM | Lapping equipment |
| | | SPM | Turning equipment |
| | | PDM | Turning equipment |
| | | MK and ENT | Grinding equipment |
| | | CW-1000 | Welding equipment |

Testing Technology:

| Mobile Testing Technology | | Stationary Testing Technology | |
|---------------------------|--|--|--|
| PS-T/SV5 (SV/A) | | PS-15M/30M/50M/75M (SV/A) | |
| PS-T10.02 (SV/A) | | PS-SV 15M/30M/50M/75M (SV) | |
| EFCO-VALVE-DOC (SV/A) | | PS-100/150 (A) | |
| | | PS-H 200M/250M/300M/350M/400M/450M/500M/550M (A) | |
| | | EFCO-Booster | |

SV = safety valve A = shut-off and control valves

Cleaning And Inspection:

| Mobile Machining | | Stationary Machining | |
|------------------|--|----------------------|--|
| ARS | Cleaning set | | |
| TSM | Mirror set | | |
| | Protractor for gate valve sealing surfaces | | |



VALVA-S1

VALVA SERIES

Portable machine for grinding and lapping of flat sealing surfaces on valves, valve disks and flanges from DN 8-1600 mm (¼"-64").

Drive: electric 230/120 V, 50/60Hz or pneumatic 6-7 bar

The VALVA series: an impressive concept = simple, easy, one-man operation, wear-resistant tools, good price/performance ratio, high profitability and efficiency. The VALVA-SV1 has been developed for machining safety valves.

| Type | DN | Grinding | Lapping |
|-----------|--------------------|----------|---------|
| VALVA-S1 | 8-150 (¼"-6") | • | |
| VALVA-SV1 | 20-150 (¾"-6") | • | |
| VALVA-1 | 8-150 (¼"-6") | • | • |
| VALVA-S15 | 80-300 (3"-12") | • | |
| VALVA-15 | 80-300 (3"-12") | • | • |
| VALVA-2 | 200-700 (8"-28") | • | • |
| VALVA-3 | 500-1600 (20"-64") | • | • |

Dimensions in mm (inch)

VSK SERIES

Special tools for the grinding of conical sealing surfaces in:

- High-pressure, shut-off, control and globe valves of DN 8-300 mm (¼"-12")
- Standard seat angles of 30° (2x15°), 40° (2x20°), 60° (2x30°), 75° (2x37,5°), 90° (2x45°) (other angles and dimensions on request)

Drive: electric 230/120 V, 50/60Hz or pneumatic 6-7 bar

| VSK* | 1 | 2 | 3 | 4 | 5 |
|------|---------|----------|---------|---------|----------|
| DN | 8-50 | 8-65 | 8-100 | 80-150 | 80-300 |
| | (¼"-2") | (¼"-2½") | (¼"-4") | (3"-6") | (3"-12") |

Dimensions in mm (inch)

*Please state seat angle in enquiries.

VSK





LS

LS SERIES

Special tools for grinding flanged pipe ends with metallic lenticular gaskets 140° as per BASF- and DIN 2696 standard from DN 6-200 mm (¼"-8").

Drive: electric 230/120 V, 50/60Hz or pneumatic 6-7 bar

| LS | 1 | 2 |
|----|---------------|---------------|
| DN | 6-90 (¼"-3½") | 6-200 (¼"-8") |

Dimensions in mm (inch)



SL-2

SL SERIES

Portable grinding and lapping machine for the repair of sealing surfaces in gate valves and non-return valves and on wedges and flanges of DN 20-2000 mm (¾"-80").

Drive: electric 230/120 V, 50/60Hz or pneumatic 6-7 bar

| | SL-05 | SL-1 | SL-15 | SL-2 | SL-3 |
|-----------------|-------------------|--------------------|---------------------|---------------------|-----------------------|
| DN | | | | | |
| Standard | 20-65 (¾"-2½") | 32-150 (1¼"-6") | 40-300 (1½"-12") | 200-700 (8"-28") | 500-1600 (20"-64") |
| Special up to | 80 (3") | 200 (8") | 450 (18") | 900 (36") | 2000 (80") |
| Immersion depth | | | | | |
| Standard | 250 (9.8") | 400 (15.7") | 600 (23.6") | 1000 (39.4") | 1200 (47.2") |
| Special up to | 400 (15.7") | 600 (23.6") | 1200 (47.2") | 1600 (62.9") | 2200 (86.6") |
| Min. spacing | | | | | |
| | 15 (0.59") | 28 (1.1") | 41 (1.6") | 69 (2.7") | 102 (4") |

Dimensions in mm (inch)

Other immersion depths can be supplied on request.

Option:

- Digital rocker (for the exact reproduction of the set contact pressure)
- Swing-check-adapter (for machining the sealing surfaces in non-return valve housings with large inclination)
- VB device:
additional arm for grinding and lapping flat sealing surfaces in valve housings.



SLA SERIES

Planetary gears with driven high-speed spindles for the machining of hard sealing surfaces ($\geq 35\text{HRC}$) for SL-15 and SL-2 machines (patented).

Time saving up to 90%.

Available as option for new machines and for retrofitting to existing SL machines.

Driven planetary gears

| Type | SLA-15* | SLA-2** |
|------|-----------------------------|-----------------------------|
| AS-1 | DN 125-175 (5"-7") (Option) | |
| AS-2 | DN 175-225 (7"-9") | DN 200-225 (8"-9") (Option) |
| AS-3 | DN 225-400 (9"-16") | DN 225-400 (9"-16") |
| AS-4 | | DN 400-600 (16"-24") |

Dimensions in mm (inch)

* for SL-15 machines ** for SL-2 machines

AS-3



HSL-15



HSL SERIES

Portable machine for high-speed grinding of hard sealing surfaces ($\geq 35\text{HRC}$) in high-pressure gate valves and wedges of various design.

Fitted with SLA series planetary gears for use with driven GSS grinding spindles.

Drive: electric 230/120 V, 50/60Hz or pneumatic 6-7 bar

| Type | HSL-15 | HSL-2 |
|---------------|---------------------|---------------------|
| Working range | DN 175-400 (7"-16") | DN 225-600 (9"-24") |

Dimensions in mm (inch)

- Grinding speed up to 21 m/s (826.8"/s)
- Very high material removal of up to 2 mm/h /0.08"/h (for Stellite 6/21 dia. 350/300 (13.8"/11.8"))
- Time saving up to 90%!
- Patente

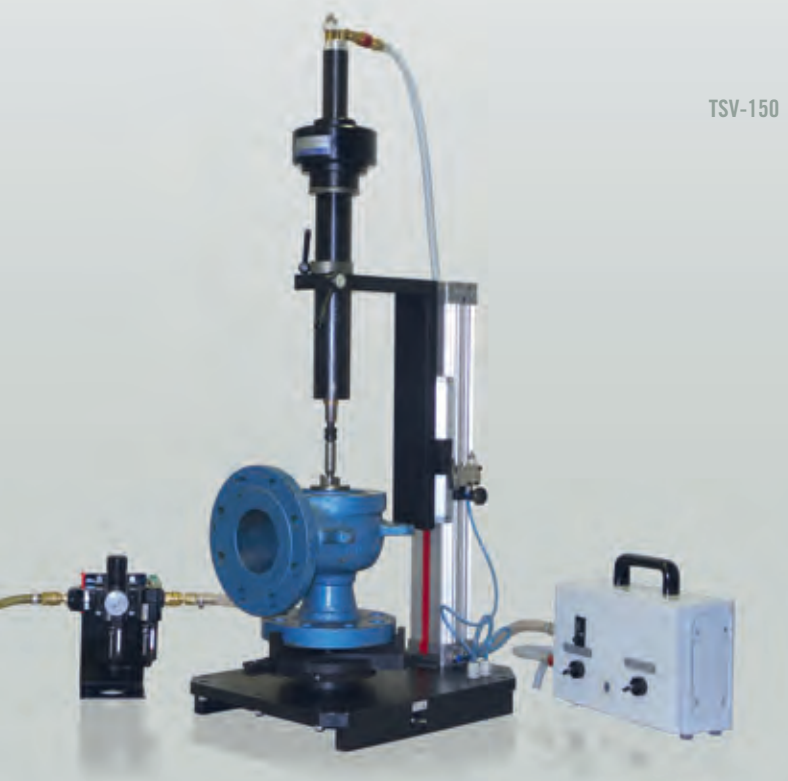

TSV-150

TSV SERIES

Portable grinding and lapping machine with eccentricity for the machining of sealing surfaces/nozzles of in safety valves of DN 15-300 mm (1/2"-12").

In these machines the grinding movement is overlaid by an additional eccentric movement. This results in a cross-hatch finish and absolutely flat sealing surface.

Suitable for use on-site and in the workshop.

| | TSV-150 | TSV-300 |
|-------------------------|------------------------|--|
| DN range | 15-150 (1/2"-6") | 25-300 (1"-12") |
| Max. immersion depth | 350 (14") | 350 (14") |
| Clamping range of chuck | 85-450 (3.4"-17.7") | 85-450 (3.4"-17.7") |
| Max. spindle speed | 330 rpm | 170 (245*) rpm |
| Max. eccentric speed | 520 rpm | 555 (805*) rpm |
| Eccentricity | 3 (0.12") | 3 (0.12") |
| Drive | pneumatic 6-7 bar | 230/120V, 50/60 Hz or pneumatic 6-7 bar* |

Dimensions in mm (inch)



VSA-2

VSA SERIES

High-speed precision grinding machine for the machining of build-up welding, sealing surfaces, conical surfaces and bores in valves, cylinders, pump housings and flanges of DN 20-1500 mm (3/4"-59").

Drive: pneumatic 6-7 bar

| Type | Working range | Immersion depth |
|--------|-----------------------|-----------------|
| VSA-05 | DN 20-150 (3/4"-6") | 250 (9.8") |
| VSA-1 | DN 50-400 (2"-16") | 650 (25.6") |
| VSA-2 | DN 250-800 (10"-32") | 1000 (39.4") |
| VSA-3 | DN 500-1500 (20"-59") | 1500 (59") |

Dimensions in mm (inch). Other dimensions on request.

A bore grinding unit and a manhole grinding unit can be supplied as accessories.



KS SERIES

Grinding table for face grinding wedges, valve disks and other machine components.

| | KS-6 | KS-10 |
|-----------------------------|---------------------------------|---------------------------------|
| Grinding disk \varnothing | 600 (23.6") | 1000 (39.4") |
| max. workpiece weight | 50 kg | 200 kg |
| Drive | electric 230/120 V, 50/60 Hz | electric 380-480 V, 50/60 Hz |

The grinding disk is fitted with self-adhesive grinding plates.

A version with quick-change grinding disks is available for use with frequently changing grits (KS-6 only).

Safe operation due to stop bracket and footswitch.

KS-6



FLM-600

FLM SERIES

Stationary surface lapping machines, particularly suitable for the lapping of valve disks, axial face seals and wedges etc.

Drive: electric 380-480 V, 50/60 Hz (FLM-400: 230/120 V, 50/60 Hz)

| Type | Lapping wheel dia. | Max. workpiece dia. | Max. workpiece weight |
|----------|--------------------|---------------------|-----------------------|
| FLM-400 | 405 (15.9") | 120 (5") | 10 kg |
| FLM-600 | 615 (24.2") | 220 (9") | 50 kg |
| FLM-900 | 915 (36") | 350 (14") | 100 kg |
| FLM-1200 | 1215 (47.8") | 470 (19") | 150 kg |
| FLM-1500 | 1515 (59.6") | 600 (24") | 150 kg |

Dimensions in mm (inch)

Accessories such as interference lamp, optical flats, polishing tables and roughness testers as well as consumables can also be supplied.

SM-550 SERIES

Stationary grinding and lapping machine for the machining of sealing surfaces in shut-off valves, wedges, safety valves, etc.

The machine can be supplied optionally with one or two tables in various configurations.

Drive: electric 230/120 V, 50/60 Hz

| | Inclined table | Rotary table |
|---------------------|-------------------------|----------------|
| Size | 550 x 550 (21.7"x21.7") | Ø 550 (21.7") |
| Adjusting distance* | – | 0-20 (0-0.78") |
| Inclination | ± 12° | – |
| Max. valve diameter | Ø 900 (36") | Ø 900 (36") |
| Max. valve height | 800 (32") | 830 (33") |
| Max. valve weight | 450 kg | 450 kg |

Dimensions in mm (inch)

* the movement of the turntable and the superposition of the rotating movements (work spindle to turntable) produce an optimum sealing surface on safety valves.

SM-550



SM-750 SERIES

Stationary grinding and lapping machine for the machining of sealing surfaces in shut-off valves, wedges, safety valves, etc.

The machine can be supplied with centre or eccentric spindle and one or two inclined tables.

Drive: electric 380-480 V, 50/60 Hz

| | SM-750 centred | SM-750 eccentric |
|---------------------|------------------------------|------------------------------|
| Spindle | centred | eccentric 0-20 (0-0.78") |
| Inclined table size | 750 x 750 (29.5" x 29.5") | 750 x 750 (29.5" x 29.5") |
| Inclination | ± 12° | ± 12° |
| Max. valve diameter | Ø 950 (38") | Ø 950 (38") |
| Max. valve height | 1000 (40") | 1000 (40") |
| Max. valve weight | 2500 kg | 2500 kg |

Dimensions in mm (inch)



MK and ENT SERIES

The pillar or radial drilling machine with MK-ADAPTER makes it possible to use the EFCO tools of the Valva and SL series for stationary machining of sealing surfaces in and on valves and wedges.

We recommend the appropriate inclined tables (0°-12°) for fast alignment of valve housings and wedges.

| Adapter | Inclined table | EFCO machines | up to DN |
|---------|--------------------------------------|-------------------|------------------------|
| MK2 | ENT-1 300 x 300 (11.8" x 11.8") | Valva-1, Valva-S1 | 150 (6") |
| | ENT-2 500 x 500 (19.7" x 19.7") | Valva-15 SL-15 | 300 (12") 400 (16") |
| MK 3 | ENT-3 1000 x 1000 (39.4" x 39.4") | SL-2, Valva-2 | 600 (24") |
| MK 5 | ENT-4 1500 x 1500 (59" x 59") | SL-3, Valva-3 | 1200-1600 (48"-64") |

Dimensions in mm (inch)

PORTABLE LATHES



TD SERIES

Portable lathe for on-site machining on valves, flanges, pumps, turbine housings.

Particularly suitable for turning cylindrical and conical sealing surfaces in high-pressure valves (internal seals) and for the removal of welded-in valve seats.

Drive: electric 230/120 V, 50/60Hz or pneumatic 6-7 bar

| Type | TD-03 | TD-1* | TD-2.02* |
|---------------|-------------------|--------------------|--------------------|
| Machining Ø | 0-150 (0-5.9") | 0-400 (0-15.7") | 0-800 (0-31.5") |
| Working depth | 250 (9.8") | 350 (13.8") | 600 (23.6") |
| Radial stroke | 20 (0.79") | 40 (1.57") | 60 (2.36") |
| Axial stroke | 100 (3.94") | 120 (4.72") | 250 (9.8") |

Dimensions in mm (inch)

*Optional unit for high-speed grinding can be supplied.

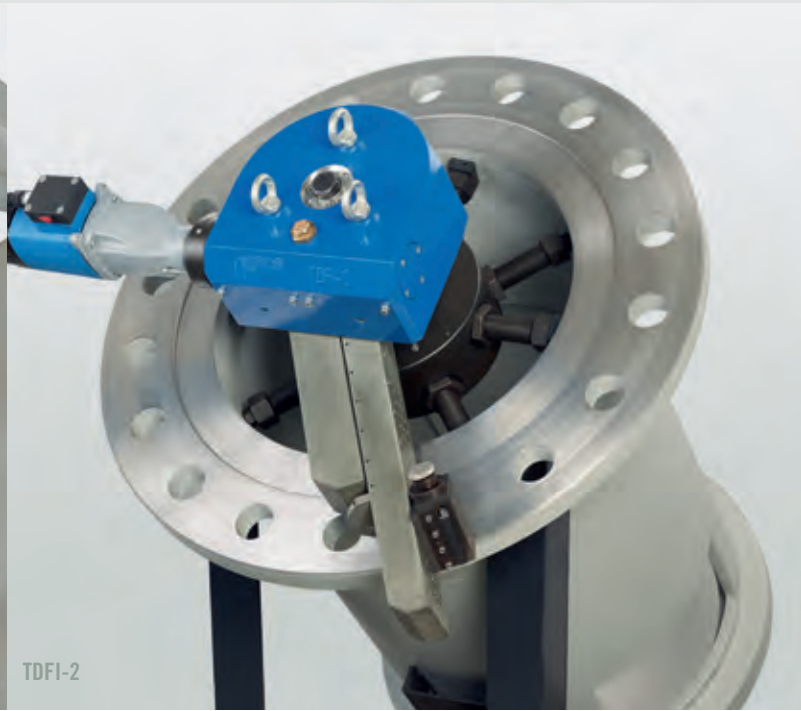

Portable flange facers with internal or external clamping for on-site machining on flanges, valves, pumps, turbine housings and heat exchangers.

Drive: electric 230/120 V, 50/60 Hz or pneumatic 6-7 bar

TDFI SERIES

- with internal clamping
- machining \varnothing 150-2200 mm (5.9"-86.6")
- easier handling due to separate installation of clamping device and machine unit
- precision alignment of clamping device within a short time by means of simply designed adjusting system

Numerous machining options:

Only TDFI Series:

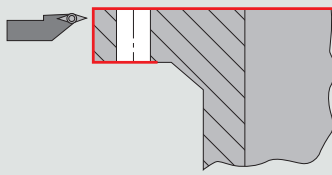

Only TDF Series:

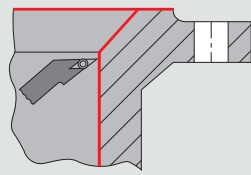

TDFI Series & TDF Series:

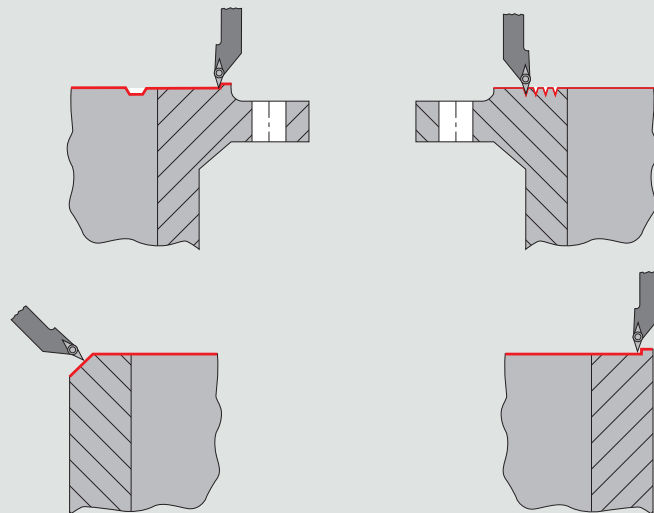

| Type | TDFI-1 | TDFI-2 | TDFI-3 |
|----------------------------|-------------------------|---------------------------|---------------------------|
| Machining \varnothing | 150-610 (5.9"-24") | 400-1200 (15.8"-47.2") | 760-2200 (29.9"-86.6") |
| Installation \varnothing | 150-460 (5.9"-18.1") | 400-1000 (15.8"-39.4") | 760-2000 (29.9"-78.7") |
| Machine height | 300 (12") | 350 (14") | 500 (20") |
| Axial stroke | 20 (0.79") | 30 (1.2") | 50 (1.97") |
| Radial stroke | 80 (3.15") | 100 (3.94") | 300 (11.8") |
| Radial feed | 0,1 / 0,5 | 0,06 / 0,1 / 0,5 | 0,06-1 |
| mm / rev | (0.004"/0.02") | (0.002"/0.004"/0.02") | (0.002"-0.04") |

All information in mm (inches)





TDF SERIES

- with external clamping
- machining \varnothing 0-3500 mm (0"-137.8")

| Type | TDF-05 | TDF-05A | TDF-1 | TDF-1A |
|---|-------------------------|-------------------------|--------------------------|--------------------------|
| Machining dia. | 0-250 (0-9.8") | 0-250 (0-9.8") | 0-500 (0-19.7") | 0-400 (0-15.7") |
| Mounting dia. | 250-400 (9.8"-15.7") | 250-400 (9.8"-15.7") | 260-600 (10.2"-23.6") | 260-600 (10.2"-23.6") |
| Machine height | 230 (9") | 310 (12.2") | 230 (9") | 310 (12.2") |
| Axial stroke | — | 30 (1.2") | — | 30 (1.2") |
| Axial stroke with angular head (optional) | 60 (2.36") | 60 (2.36") | 60 (2.36") | 60 (2.36") |
| Radial stroke | 80 (3.15") | 80 (3.15") | 80 (3.15") | 80 (3.15") |
| Radial feed mm/rev | 0,1/1 (0.004"/0.04") | 0,1/1 (0.004"/0.04") | 0,1/1 (0.004"/0.04") | 0,1/1 (0.004"/0.04") |

Dimensions in mm (inch)

| Type | TDF-2 | TDF-3 | TDF-4 |
|---|---------------------------|---------------------------|---------------------------|
| Machining dia. | 300-1200 (11.8"-47.2") | 700-2200 (27.5"-86.6") | 1500-3500 (59"-137.8") |
| Mounting dia. | 485-1345 (19.1"-53") | 750-2400 (29.5"-94.5") | 1500-3700 (59"-145.7") |
| Machine height | 350 (13.8") | 450 (17.7") | 760 (29.9") |
| Axial stroke | — | — | — |
| Axial stroke with angular head (optional) | 80 (3.15") | 80 (3.15") | 80 (3.15") |
| Radial stroke | 100 (3.9") | 150 (5.9") | 200 (7.9") |
| Radial feed mm/rev | 0,1/1 (0.004"/0.04") | 0,1/1 (0.004"/0.04") | — |
| Radial feed mm/min | — | — | 0-10 (0"-0.04") |

Dimensions in mm (inch)

Special versions on request

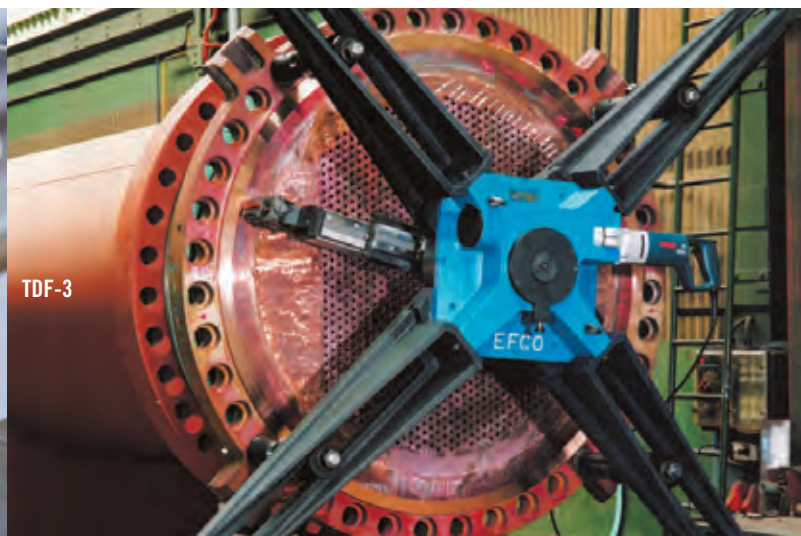

Portable CNC-controlled lathes and flange facers with two controlled axes (X+Z) for on-site use on flanges, valves, pumps, turbine housings and heat exchangers.

End faces and holes, tapers, radii and grooves can be machined in one clamping operation using these machine variants.

Drive: electric 380-480 V, 50/60 Hz

TDF-NC SERIES

Portable CNC-controlled flange facer with external clamping.

| Type | TDF-2NC |
|-------------------------|--------------------------|
| Machining Ø | 500-1500 (19.7"-59") |
| Installation Ø | 1200-2600 (47.2"-102.4") |
| Axial stroke | 80 (3.2") |
| Radial stroke | 400 (15.8") |
| Axial feed mm/min | 0-69 (0-2.7") |
| Radial feed mm/min | 0-500 (0-19.7") |
| Spindle speed [rev/min] | 0-50 |

All information in mm (inches)

Other dimensions on request

TD-NC SERIES

Portable CNC-controlled lathe with external clamping.

Particularly suitable for machining with large immersion depths.

| Type | TD-2.02 NC |
|-------------------------|--------------------------|
| Machining Ø | 0-800 (0-31.5") |
| Installation Ø | 400-1100 (15.8" - 43.3") |
| Working depth* | 600 (23.6") (Standard) |
| Axial stroke | 250 (9.8") |
| Radial stroke | 60 (2.4") |
| Axial feed mm/min | 0-270 (0-10.6") |
| Radial feed mm/min | 0-150 (0-5.9") |
| Spindle speed [rev/min] | 5-120 |

All information in mm (inches)

Other dimensions on request

*Working depths of more than 1500 mm (59") possible

Machining options:

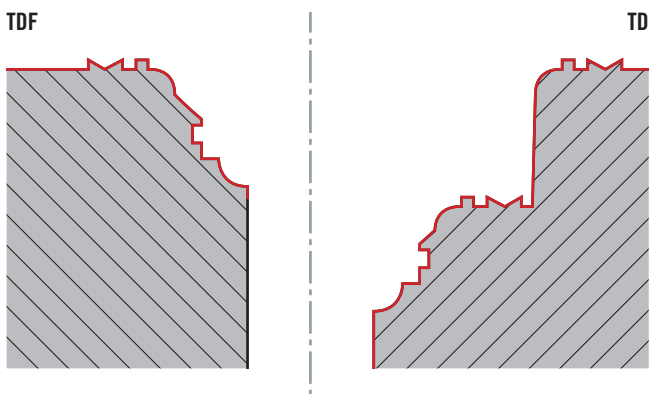

TDF-2NC



TD-2.02 NC



CNC-controlled vertical lathes for manufacturing or machining end faces, cylindrical surfaces, tapers, radii and grooves.

The optimum solution for complete machining and general overhauling of valves.

The CNC-controlled machines have precision tilt tables ($\pm 12^\circ$, accuracy $\pm 10''$) and have been designed for machining valves in a more efficient way. The flexible design means that the machine can also be used for other machining tasks.

Drive: electric 380-480 V, 50/60 Hz

PDM SERIES

- Manual tilt adjustment
- The table axis is clamped manually

| Type | PDM-600 |
|-------------------------|---------------------------|
| Machining \varnothing | 80-600 (3.2"-23.6") |
| Machining height | 650 (26") |
| Precision tilting table | 600 x 600 (23.6" x 23.6") |

All information in mm (inches)

SPM SERIES

- Motorised tilt adjustment
- The table axis is clamped hydraulically

| Type | SPM-802-N |
|-------------------------|-----------------------------|
| Machining \varnothing | 80-1000 (3.2"-39.4") |
| Machining height | 1300 (52") |
| Precision tilting table | 1000 x 1000 (39.4" x 39.4") |

All information in mm (inches)

PDM-600



SPM-802-N





PS SERIES

Valve test benches can be used for various applications.

These are, for example, the incoming goods test when new valves are delivered, the intermediate and final inspection during/after valve manufacture, checking the valve repair result or routine testing of, for example, safety valves.

The tests comprise mainly pressure tests of valve housings, leakage tests of the valve seats and testing of the set pressure of safety valves in particular.

In addition to valves, other components, too, can obviously be subjected to a pressure test. These are, for example, tanks, motor housings, pump housings, pipe fittings, insulators, etc. Special clampings are frequently required to clamp these test pieces.

An EFCO valve test bench consists of a clamping unit and a control panel for operation, measurement, and control. The test piece is held securely by the clamping device and sealed on inlet and outlet for the test. Clamping forces up to about 1500 t can be implemented (on request even higher).

The operating/measuring/control unit (console) is used for the actual test (filling of the valve, building up of test pressure, controlling the clamping unit, measuring of test pressure).

We also offer small, portable test units for mobile applications. These test units do not have a clamping unit and can be used to build up test pressure and measure it (e.g. for tank tests).

Construction of valve test benches

- Stationary / portable (available up to about 10 t clamping force)
- Manual / automatic
- Horizontal/vertical/tilting

For the testing of

- Gate valves
- Control valves
- Check valves
- Ball valves
- Safety valves
- Hollow bodies (motor housings, pipe fittings, tanks, etc.)

Design of test piece ends (inlet/outlet)

- Flange
- Thread
- Welding socket pieces
- Flangeless ("sandwich" / "wafer")

Test medium

- Water
- Air
- Nitrogen
- Special test media (e.g. oil, kerosene)

Test types

- Shell/body tests
- Leakage test of spindle gland
- Leakage test of shut-off device
- Set pressure of safety valves

Test pressure

- Water up to 1380 bar (20000 psi) (higher on request)
- Air / nitrogen up to 300 bar (4350 psi) (higher on request)
- Vacuum testing

PS-200





EFCO standard testing equipment

Well-tries technology, standardised and with modular design. Cost-effective and with short delivery times. Basic product range in various versions and many options.

The standard testing technology is characterised by:

- Easy to operate
- Manual operation
- Infinitely variable clamping force
- Suitable for pressure testing of shut-off/control valves and safety valves
- Water tank made from stainless steel (VA)
- All parts of clamping device with anticorrosive coating

Vertical chucking

| Type | DN | Clamping force (t) |
|----------------|-------------------|--------------------|
| PS-T/SV5 | 10-80 (3/8"-3") | 5 |
| PS-T10.02 | 10-200 (3/8"-8") | 10 |
| PS-15M | 15-250 (1/2"-10") | 15 |
| PS-SV15M | 15-250 (1/2"-10") | 15 |
| PS-30/50/75M | 25-400 (1"-16") | 30/50/75 |
| PS-SV30/50/75M | 25-400 (1"-16") | 30/50/75 |
| PS-100 | 50-500 (2"-20") | 100 |
| PS-150 | 50-500 (2"-20") | 150 |

Horizontal clamping

| Type | DN | Clamping force (t) |
|----------|-----------------------------------|--------------------|
| PS-H200M | 50-600 / 100-1000 (2"-24"/4"-40") | 200 |
| PS-H250M | 50-600 / 100-1000 (2"-24"/4"-40") | 250 |
| PS-H300M | 50-600 / 100-1000 (2"-24"/4"-40") | 300 |
| PS-H350M | 50-600 / 100-1000 (2"-24"/4"-40") | 350 |
| PS-H400M | 50-600 / 100-1000 (2"-24"/4"-40") | 400 |
| PS-H450M | 50-600 / 100-1000 (2"-24"/4"-40") | 450 |
| PS-H500M | 50-600 / 100-1000 (2"-24"/4"-40") | 500 |
| PS-H550M | 50-600 / 100-1000 (2"-24"/4"-40") | 550 |

Other variants on request

Dimensions in mm (inch)

PS-15M



PS-T10.02



PS-H550M

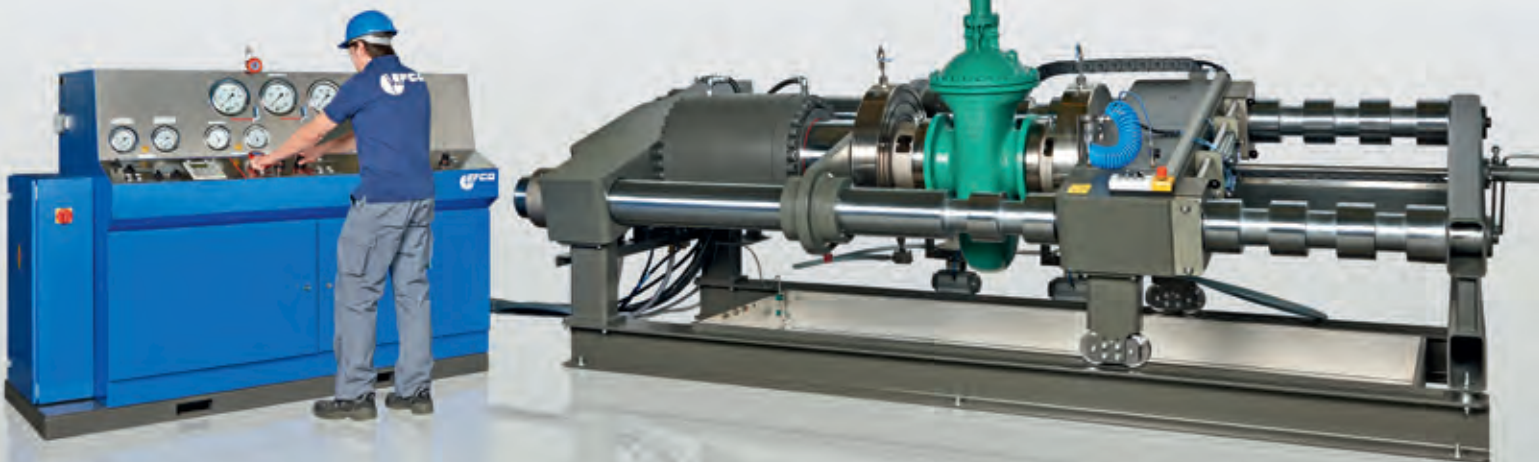



Individually adapted testing equipment, coordinated to your particular specifications and needs.

Our particular strength lies in creating a product for you that meets your requirements exactly. You benefit from our many years of experience in implementing customer-specific projects.

Here is a small selection of a wide range of options:

- Nominal test specimen widths (DN10/ 3/8") up to (DN1000/ 40") and larger
- Manual, semi-automatic or automatic operation
- Repeated test cycles (endurance testing)
- Underwater testing
- Vacuum testing
- Testing of 2-way / 3-way / multi-way test specimens
- Individual or multiple clamping
- Recording of test specimen ID using handheld scanner
- Output of test result data via defined interface

PS-50UW

- Automatic air and water shut-off valve testing
- Air testing under water
- Clamping unit that swings out to allow for easy installation

PS-30A

- Automatic air and water testing of 2 and 3-way control valves
- Actuator for closing and opening the test specimen
- Proportional clamping to protect housing



PS-50UW

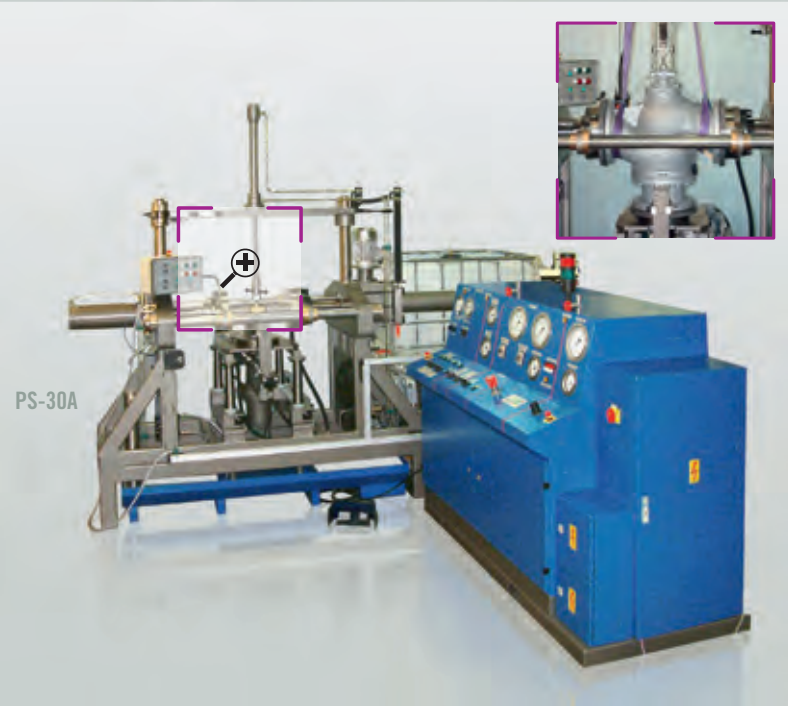

PS-30A



PS-H90A



PS-H7.5UW

- Fully automatic testing of ball valves
- Air testing under water
- Torque measurement when closing
- Horizontal clamping

PS-H1500

- For testing valves up to DN 1000 (40")
- Water testing up to 1380 bar (20.000 psi)
- Housing-protecting horizontal clamping with self-sealing test tables

PS-H7,5 UW



PS-H1500



PS Bellows testing device

- For air testing of bellows
- Automatic testing procedure
- Multiple clamping (photo: 3-way vertical)

PS-H90A

- Fully automatic air and water testing of gate valves and butterfly valves DN40-600 (1½"-24")
- Torque measurement when closing
- Horizontal clamping
- Test specimen ID recorded using hand scanner
- Transfer of test result data to network interface
- Proportional, housing-protecting clamping





EFCO-VALVE-DOC

The EFCO-Valve-Doc is a documentation and administration system for valve test:

- Mobile or stationary device for the acquisition, analysis and documentation of valve tests
- Suitable for all test benches on the market
- User friendly
- Designed with the latest technology
- Available in several languages

The EFCO-Valve-Doc is ready to be used; all software is installed and configured. It only needs to be plugged in, and the pressure transducers need to be connected to the valve test bench.

It is to log, record and analyse:

- Set-pressure and seat leakage tests of safety valves and / or
- Body leakage and seat leakage tests of shut-off valves

EFCO-BOOSTER

Water pressure generation with appropriate high-pressure pumps is integrated in every EFCO valve test bench intended for a water test.

The air/nitrogen test pressure required for testing is provided either via a high-pressure bottle pre-filled by the customer or via an EFCO Booster.

The EFCO Booster compresses air or nitrogen to 300 bar (4350 psi) (higher pressures are possible on request).

BOOSTER



PS ACCESSORIES

All EFCO valve test benches are equipped with standard accessories and their function can be extended with optional accessories.

The following are some of the accessories available:

- O-ring sealing plates
- Polyurethane sealing plates (Vulkollan)
- Safety plugs (specially for safety valves)
- Threaded adapters (for the testing of test pieces with threaded end)
- Accumulators
- Digital displays

EFCO WELDING EQUIPMENT

CW-1000 SERIES

DN 30-1000 mm (1¼"-40").

Complete solution for MIG/MAG welding in and on valves.

Automatic welding of sealing faces/circular welding of:

- bores, circular and conical surfaces

The machine is equipped with automatic feed and has integrated water cooling.

Drive: electric 230/120 V, 50/60 Hz

| Type | CW 1000 |
|-------------------|--|
| Axial stroke | 175 (6.89") |
| Radial stroke | 90 (3.54") |
| Axial feed /rev. | 3 (0.12") |
| Radial feed /rev. | 3 / 3,8 / 4,6 (adjustable) (0.12"/0.15"/0.18") |
| Speed range | 0,1 - 5,0 rpm |
| Adjustment angle | of head 0 - 90° (manually) |

Dimensions in mm (inch)

CW-1000



ARS

EFCO-ARS-SERIES

Professional cleaning set for valves to remove rust, seal residues, scale, slag, paint residue and other contamination.

Developed for cleaning of dirty valves or housings using high-speed rotating twisted brushes.

Drive: electric 230/120 V, 50/60Hz or pneumatic 6-7 bar

MOBILE WORKSHOPS

As fixed lorry superstructure or in an ISO container

Fast reaction times and flexibility are required for on-site valve service. EFCO can provide you with a mobile workshop equipped to your requirements. It is equipped with EFCO turning, grinding and lapping technology and can also be fitted with a lathe, drilling machine, valve test bench and everything else you require.





EFCO ABRASIVES

The EFCO abrasives are perfectly formulated and matched to EFCO machines through extensive testing. We supply coated abrasives in various grit sizes and formulations optimised for the application.

- | | |
|-------------------|--|
| Abrasive backing: | <ul style="list-style-type: none"> • Paper • Cloth • Film |
| Grain types: | <ul style="list-style-type: none"> • Aluminium oxide (Al_2O_3) • Silicon carbide (SiC) • Zirconium corundum ($ZrO_2 + Al_2O_3$) |
| Grain size: | <ul style="list-style-type: none"> • Standard grit sizes: P80-P1800 (other grit sizes on request) |

GSS SERIES

EFCO GSS grinding tools are coated with electroplated cubic crystalline boron nitride (CBN).

CBN is highly suitable for grinding hard sealing surfaces with a minimum hardness of 35 HRC such as, for example, steel on cobalt and nickel basis, highly alloyed steels, chromium steel, etc.

The good heat resistance of CBN in combination with its great hardness makes economic grinding at the higher machining temperatures of these steels possible (long life).



EFCOBOR LAPPING COMPOUNDS

In accordance with DIN 8589, lapping is a microfinishing process using a grain distributed loosely in a liquid or paste (lapping compound) which is held on a, usually shaped, counterpart (lapping tool).

EFCOBOR lapping compounds are oil soluble lapping pastes of boron carbide.

Independent of the material hardness, with EFCOBOR it is possible to achieve:

- High surface quality
- Highest dimensional accuracy
- Close dimensional tolerances

EFCOBOR Lapping Paste comes in various grit sizes from P80-P1500 (FEPA) and pack sizes.

EFCO also supplies other equipment, machinery and materials for valve repair on-site or in the workshop and for the repair of pipelines.

- **SEAL AND PACKING CUTTING MACHINES AND EQUIPMENT**
- **INCLINOMETER FOR GATE VALVE SEALING SURFACES**
- **TSM TELESCOPIC INSPECTION MIRROR**
- **HYDRAULIC NUT OPENER**

Advice, Project Planning and Training

We offer training with our machines and equipment in our company or at your site. Valve repair training, too, is carried out competently.

Our core competence is valve repair/valve testing. We are happy to advise you and work together with you on drawing up concepts for valve repair.

Our partners are companies of different sizes from many industries.

We can design and build special machines for you which match the requirements of your company.

Within Europe, we would be pleased to visit you by arrangement with one of our demonstration vehicles to introduce you personally and competently to a large section of our product range.

We will gladly advise you at your site and also to provide any special information specific to your requirements.

You can also find us on the Internet with further product details and up-to-date information.

www.efco-dueren.com



EFCO Maschinenbau GmbH

Otto-Brenner-Straße 5-7
D-52353 Düren
Phone: +49-2421-989-0
Fax: +49-2421-86260
Email: sales@efco-dueren.de
Web: www.efco-dueren.de

EFCO USA, INC

P.O. Box 38839
Charlotte, NC 28278-1014
Phone: (800) 332-6872
(800) EFCO-USA
Fax: (888) 332-6872
(888) EFCO-USA
Email: sales@efcousa.com
Web: www.efcousa.com

EFCO MOSKAU

115054 Moskau
B.Strochenovsky Pereulok,
d.22/25, str.1, of. 501
Phone: +7 (495) 633 97 57
Fax: +7 (495) 633 97 54
Email: efcomoscow@efco-dueren.ru
Web: www.efcorussia.ru

EFCO CHINA

Rm 1202, #5 Block
D Building, Triumph Center
No. 170 Beiyuan Road
Chaoyang District
Beijing 100029, P.R. China
Phone: +86-10-5971 1096
Phone: +86-10-5971 1097
Phone: +86-10-5791 1098
Email: office@efco-beijing.com
Web: www.efco-beijing.com

EFCO MASCHINENBAU INDIA PVT. LTD.

55/A, Annaram Village,
Jinnaram Mandal, Medak District,
Telangana - 502 313, INDIA
Phone: + 91 8458 275 906
Phone: + 91 8458 275 907
Phone: + 91 8458 275 908
Fax: + 91 8458 275 101
Email: sales@efcoindia.com
Web: www.efcoindia.com

**You can find further agencies and trading partners in
many countries on our Internet pages**

*We reserve the right to make changes contributing to technical progress without
prior notification*

